

KEA

KLEAN ENVIRONMENTAL AIR FILTER BAGS



Our filter bags are singed (heat treated) on the inside to limit dust cake wall buildup that helps to capture the smallest dust particulate matter. The finer particles that is not separated from the air stream by the action of the collector are captured in the filter bag - allowing only the filtered air to be recirculated back into the environment. Our filter bags are constructed of 11 ounce polyester felt with a singed inner finish that is 99% efficient in filtering particles five microns and larger. Flame-retardant cotton sateen filter bags & custom configurations are also available.

KEA's STANDARD & TUBULAR FILTER BAGS - shown on right

Models 201, 203, and 204 bags are cylindrical in design to maximize the filtration surface area and minimize the required amount of floor space. The finer particulate matter settles to the bottom of the bag allowing the upper part of the bag area to be free to breathe and exhaust the air efficiently. The top of the bag has a strong center nylon loop for hanging. A heavy duty edge-to-edge zipper closure is on the bottom of the bag for easy emptying.

Models 217 and 219 are long and skinny tubular bags that are used internally in "bag house" dust collection systems. The closed end has a sturdy nylon 3" loop for connecting, and the open end is securely attached to the round air inlet on the bag house collector.

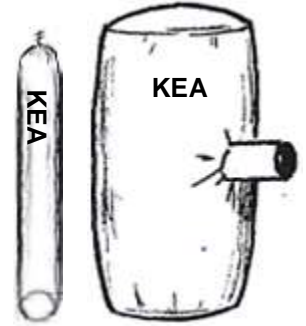

Bags: # 201, 203, & 204

Tubes: #217 & 219

LARGE & OVERSIZED FILTER BAGS – for any dust bag collector



Model #207 & 208
Oversized shown

KEA recommends large filter bag models 207 & 209, and oversized filter bag models 208 & 211 when collecting extremely fine and light dust to maximize the surface area of the bag. Our connector hose kit is required to connect these bags to the dust collector - includes five-foot long hose section, a short connector sleeve, and two hose clamps.

Models 207 (large) and 208 (oversized) drum-mount bags are suspended above a round 24" diameter drum. The fine dust settles into the drum for easy removal - saving on bag cleaning. Strong nylon loops are around the top perimeter, and one in center of the bag for hanging. About 5" of the lower portion of the bag fits inside of the drum, and the outside 4" fabric collar is secured by an elastic strap (included with each bag at no additional cost).

Models 209 (large) & 211 (oversized) hanging bags are suspended from the ceiling by 3" nylon loops around the top perimeter and one in the center of the bag. A heavy duty edge-to-edge zipper is located in the bottom of the bag for easy emptying. Our suspension ring kit includes a 24" round steel ring and (12) "S" hooks (available as an option).



Model #209 & 211

Shown with
hose kit and
steel ring

SPECIFICATIONS – Polyester Felt (P) or Flame Retardant Cotton (C) - Specify

MODEL	ITEM DESCRIPTION	SQ FT	HT	DIA	WT
201	Standard Filter Bag for ½ HP Motors	17	38"	17"	2
203	Standard Filter Bag for 1 to 2 HP Motors	28	50"	21"	2.5
204	Standard Filter Bag for 3 HP Motors	41	70"	23"	3.5
217*	3" Dia. Tubular Bag - Custom lengths available	1.7	23"	3"	1
219*	6" Dia. Tubular Bag – Custom lengths available	5.2	40"	6"	1.5
207	Large Drum Bag – for 24" diameter barrel	44	72"	24"	5
208	Oversized Drum Bag – for 24" diameter barrel	100	72"	48"	9
209	Large Hanging Bag - Ring Suspended	44	72"	24"	5
211	Oversized Hanging Bag - Ring Suspended	100	72"	48"	9
Varies	Hose Kit (5' of hose, connector sleeve, clamps)			4" / 6"	
170	24" Solid Steel Ring Kit with twelve "S" hooks				

*Model 217 & 219 available in spun polyester (SP) or polyester (PET) Square feet shown is fabric surface area

Standard Filter Bags with Zipper Bottom

All Dust Bag Hose Inlets are 6 1/4" diameter x 6 1/4" long (Custom configurations available)

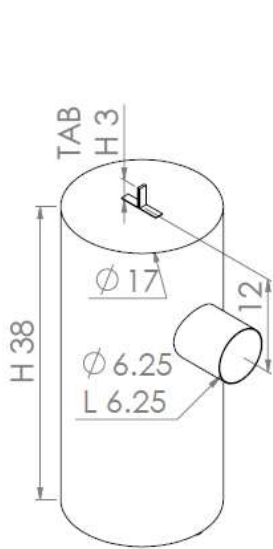

Model 201
17" Dia. x 38" H

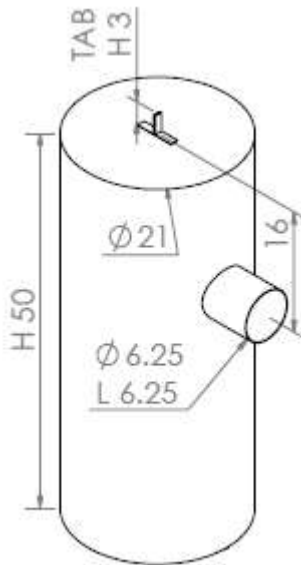

Model 203
21" Dia. x 50" H

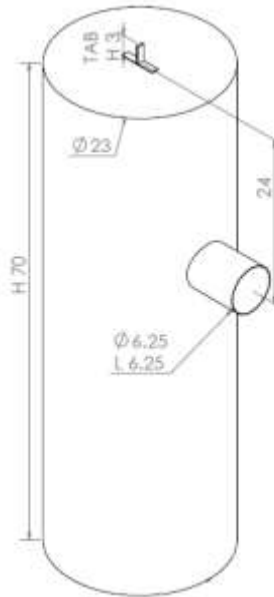

Model 204
23" Dia. x 70" H

KEA Compatibility Chart

<u>Bag#</u>	<u>Model#</u>
201:	2005, 2105
203:	2010, 2015, 2020, 2110, 2115, 2120
204:	2030, 2130
207/208:	All above
209/211:	All above
217:	2135
219:	All other bag houses

Drum-Mount & Ceiling-Mount Filter Bags

All measurements shown are in inches & for reference only

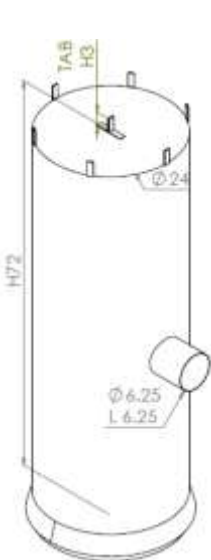

Model 207
Open to Drum
24" Dia. x 72" H

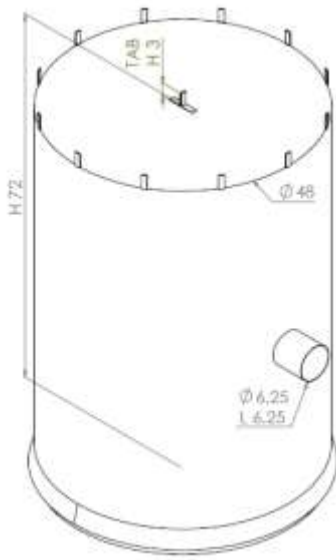

Model 208
Open to Drum
48" Dia. x 72" H
(tapered bottom)

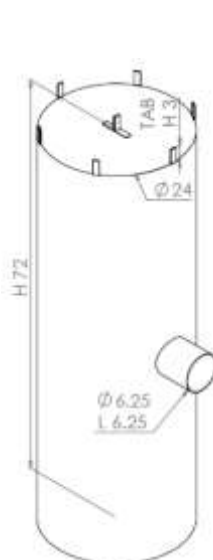

Model 209
Zipper Bottom
24" Dia. x 72" H

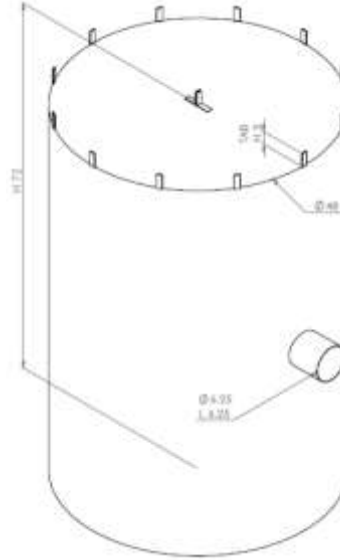

Model 211
Zipper Bottom
48" Dia. x 72" H



Model 217 & 219
Tubular
(open)